

SHEET METAL & HVAC DUCT MANUFACTURING & SUPPLY



PRODUCT CATALOG



INTRODUCTION

BGSN Mechanical Construction is the leading company in Commercial & Industrial Mechanical Services serving the Gulf Coast. We specialize in Commercial Plumbing, HVAC, Mechanical Construction, and Sheet Metal / Ductwork Fabrication.

Our in-house fabrication capabilities allow us to produce custom ductwork and mechanical components with precision, ensuring quality control, efficiency, and seamless integration with project requirements.

Duct fabrication is a critical part of any HVAC system, directly impacting airflow efficiency, system performance, and indoor air quality. Properly designed and fabricated ductwork ensures that air is distributed evenly, energy loss is minimized, and systems operate at peak efficiency.

The duct fabrication process begins with material selection, using durable options such as galvanized steel or aluminum based on the specific requirements of the project. From there, experienced professionals create a custom ductwork design that accounts for building size, layout, and ventilation demands to support efficient airflow.

During fabrication, materials are precisely cut, shaped, and assembled using specialized tools and proven techniques to match exact design specifications. The final step is professional installation, ensuring the ductwork integrates seamlessly with the HVAC system and meets all applicable codes and performance standards.

Entrusting duct fabrication to skilled professionals ensures accuracy, longevity, and reliable system operation for commercial and industrial environments.

Contact us today to schedule a consultation or request a quote.

If particular item not found below, please call us (504) 841-9775.

BGSN Mechanical Construction / BGSN Sheet Metal can custom fabricate just about any component.

Visit our webpage at www.bgsnmechanical.com

or contact us at sales@bgsnmechanical.com

Table of Contents









FULL PRODUCT LINE.....	4
ROUND DUCT, FITTINGS & ADAPTERS.....	9
Spiral Pipe	9
Snap Lock Pipe	10
Conductor Pipe.....	10
Flexible Duct	11
Aluminum Flex.....	11
Adjustable Elbows.....	12
Stamped & Spot-Welded Elbows.....	12
T-Wyes.....	13
Dual T-Wyes & Tees.....	13
Tapers & Reducers	14
Cookie Cutters	14
Dampers & Sleeves	15
3/8 Dampers w/ Sleeve	15
End Caps.....	16
Start Collars.....	16
Spin-Ins.....	16
Round Duct Connectors.....	17
Saddles	18
Boxes	19
Boots	20
China Cap.....	21
Dryer Vent	21
Eyebrow Vent.....	21
Double Wall B-Vent Pipe & Fittings.....	22
Conductor Flashings.....	22
T-Top Vent.....	22
RECTANGULAR DUCT	23
Rectangular Duct Connectors	24
Return Air Can	25

Drain Pans.....	25
Line Set Cover	25
”S” Lock Drives	26
Standing “S”	26
Angle	26
Vanes & Rails	26
Riser Pipe	27
Riser Elbows	27
Register Boxes	27
Water Heater Stands	28
Stud Guards	28
Stud Shoes.....	28
Nail Protection Plates	29
BOCA Plates.....	29
Pipe Clamps.....	30
Tub Hangers	30
Heavy Duty Hinges	30
Access Doors.....	31
Hangers & Supports	32
Dampers Hardware & Screws.....	34
Duct & Fire Wrap.....	35
Duct Cover Film.....	35
Flex Connector	35
Rod Anchors	36
Hanger Hardware.....	37
Duct & Foil Tape.....	38
Duct Sealer, Adhesives & Fire Stop.....	38
Copper Fittings	39
Copper Line Set.....	39
PVC Pipe & Fittings	39
Service Gases.....	40
Brazing Alloy	40
Black Iron Pipe & Fittings.....	40

Gas Line / Connectors.....	40
Thermostat Wire.....	41
Whip Kits.....	41
Pigtails / Power Cords.....	41
Disconnect & Fuses.....	41
Coil Cleaner.....	42
Freon.....	42
Zip Ties.....	42
Stamped Grilles & Registers.....	43
Stamped Return & Filter Grilles.....	43
Bar Type Grilles & Registers.....	44
Bar Type Return & Filter Grilles.....	44
T-Bar Perforated Supply Diffuser.....	45
T-Bar Cone Supply Diffuser.....	45
T-Bar Perforated Return Air Diffuser.....	45
Louvers.....	46
Fire / Smoke Dampers.....	47
Backdraft Dampers.....	47
Control Dampers.....	47
Smoke Detectors.....	48
Gas Detection System.....	48
SUBMITTAL FORMS.....	49
Rectangular Duct & Fittings.....	49
Round Duct & Fittings.....	50

FULL PRODUCT LINE

				
SPIRAL PIPE	CONDUCTOR PIPE	SNAP LOCK PIPE	FLEX DUCT	ALUMINUM FLEX
				
T-WYE	DUAL T-WYE	DUAL TEE	TRUE TEE	AIRFLOW TEE
				
PANT WYE	SPLITTER WYE	90° ADJ. ELBOW	45° ADJ. ELBOW	90° SPOT WELDED ELBOW
				
45° SPOT WELDED ELBOW	90° STAMPED ELBOW	45° STAMPED ELBOW	90° FLAT SADDLE	45° FLAT SADDLE
				
90° RADIUS SADDLE	45° RADIUS SADDLE	COLLAR	CONDUCTOR FLASHING	T-TOP VENT
				
SPIRAL COUPLING	END CAP	COOKIE CUTTER	TAPER	TAPER W/ COLLAR

				
CHINA CAP	DOUBLE WALL B-VENT	EYEBROW VENT	CEILING BOX (TOP FEED)	CEILING BOX (SIDE FEED)
				
FLOOR BOX	DRAIN PANS	FAU STAND	RETURN AIR CAN	DRYER VENT
				
STANDARD RIGHT BOOT	STANDARD STACKHEAD BOOT	STANDARD CONE BOOT	PERIMETER STRAIGHT BOOT	PERIMETER STACKHEAD BOOT
				
PERIMETER CONE BOOT	RISER PIPE	STD. 90° & 45° RISER ELBOW	FLAT 90° & 45° RISER ELBOW	REGISTER BOX
				
LINE SET COVER	SQUARE TO ROUND	STRAIGHT SPIN-IN	CONICAL SPIN-IN	SLEEVE W/ DAMPER
				
PLENUM END CAP	RECTANGULAR PLENUM W/ CAP	DUCT W/ CONNECTOR	DUCT 90° ELBOW	DUCT NON 90° ELBOW

				
L-SECTION DUCT	RECTANGULAR TEE	TRANSITION	TRANSITIONAL OFFSET	STRAIGHT OFFSET
				
PANT FITTING	CROSS TEE	GOOSE NECK	RECTANGULAR SADDLE	PARKER FITTING
				
ROOF CURB	FLEX CONNECTOR	ANGLE	ANGLE RING	DURA FLANGE
				
"S" LOCK	STANDING "S"	FLAT DRIVES	FLANGES	VANE / RAIL
				
WATER HEATER STANDS	PROTECTION PLATES	STUD GUARDS / SHOES	PIPE CLAMPS	TUB HANGER
				
GASKET	CORNERS	ACCESS DOORS	ROUND DOOR	FIRE DOOR

 <p>JIFFY / DAMPER ASSEMBLY</p>	 <p>DAMPER HARDWARE</p>	 <p>BOLTS, NUTS & WASHERS</p>	 <p>TEK / ZI SCREWS</p>
 <p>CLEAT</p>	 <p>DUCT WRAP</p>	 <p>FIRE WRAP</p>	 <p>WELD PIN</p>
 <p>CONDUIT LOCK</p>	 <p>RIVETS / GUN</p>	 <p>SCREWS / NUT DRIVERS</p>	 <p>SHEET METAL TOOLS</p>
 <p>REGISTER</p>	 <p>GRILLE</p>	 <p>DIFFUSER</p>	 <p>FILTERS</p>
 <p>THERMOSTAT WIRE</p>	 <p>COPPER LINE SETS</p>	 <p>SMOKE DETECTOR</p>	 <p>GAS DETECTION SYSTEM</p>
 <p>WHIP KITS</p>	 <p>PIGTAILS/</p>	 <p>FREON</p>	 <p>SERVICE GASES</p>
	 <p>STICK PIN</p>	 <p>GLOVES</p>	 <p>RUBBER PADS (ISO PADS)</p>
 <p>FIRE / SMOKE DAMPER</p>	 <p>COIL CLEANERS</p>		

				
GAS LINES	BLACK IRON PIPE & FITTINGS	COPPER FITTINGS	PVC PIPE & FITTINGS	BRAZING ALLOY
				
LOUVERS	HANGER STRAP	STRAP BRACKET	HANGER HARDWARE	THREADED ROD ANCHORS
				
AIRCRAFT CABLE	CLUTCHER	THREADED ROD	UNISTRUT	HANGER SUPPORT
				
DURA-BLOK	BAILING WIRE	BRUSHES	DUCT SEALANT	FIRE STOP / CAULKING
				
DUCT COVER FILM	DUCT / FOIL TAPE	SPRAY PAINT	ZIP TIES	THERMAL LABELS
				
DISCONNECT & FUSES	THERMOSTATS	EYE LAG SCREWS	EYE LAG EXTENSION POLE	SPRING HANGERS & MOUNTS

ROUND DUCT, FITTINGS & ADAPTERS

Spiral Pipe

Size	Ga.
4" – 22"	26
24" – 30"	24
32" – 36"	22
38" – 50"	20
52" – 60"	18

- Standard: 10" length galvanized steel.
- Lined or wrapped spiral available upon request.
- Stainless Steel, Aluminum, Perforated & PVC Coated Spiral Pipe available upon request.
- Other sizes, gauges & materials available.



BARE



LINED / INSULATED



WRAPPED



PVC



PERFORATED

Snap Lock Pipe

K.D. Pipe

Size
3" – 20"
<ul style="list-style-type: none">• Standard: 3' length, 5' lengths available upon request.• Line K.D. pipe available upon request.• Other sizes, gauges & materials available.



BARE / LINED

Conductor Pipe

Size
3" – 5"
<ul style="list-style-type: none">• Standard: 10' length.• Other sizes, gauges & materials available.



Flexible Duct

Soft Flex

Size	
25'L Box	5'L pieces w/ M/F Collars
4" – 20"	4" – 20"
<ul style="list-style-type: none"> • Available in metallized jacket, R4.2, R6 and R8. • 25'L made with raw ends. • 5'L made with male/female collar ends. • Other sizes, gauges & materials available. 	



Aluminum Flex

Size	
6'L Uncompressed w/ M/F Collars	10'L Compressed No Collars
5" – 20"	3" & 4"
<ul style="list-style-type: none"> • Available in bare or wrapped w/ metallized jacket. • 3" & 4" made compressed w/ crimped end. • Available in wrapped R4.2, R6 and R8. • Other sizes, gauges & materials available. 	



WRAPPED



BARE

Adjustable Elbows

Size
3" – 30"
<ul style="list-style-type: none"> • Standard: Four Gores raw and crimp each end 90 degrees Adjustable Elbow. • Standard: Two Gores raw and crimp each end 45 degrees Adjustable Elbow. • Lined Elbow available upon request. • Other sizes, gauges, & materials available upon request.



90° BARE



90 or 45°
LINED



45° BARE

Stamped & Spot-Welded Elbows

Available Upon Request			
			
90° STAMPED ELBOW	45° STAMPED ELBOW	90° SPOT WELDED ELBOW	45° SPOT WELDED ELBOW
<ul style="list-style-type: none"> • Stamped Elbow available in 3" - 12" upon request, in short or long radius, in 22 & 24 Ga. • Other sizes, gauges, & materials available upon request 			

T-Wyes

Size		
8 x 6 x 6	12 x 10 x 10	16 x 14 x 10
8 x 8 x 6	12 x 12 x 8	16 x 14 x 12
9 x 7 x 7	14 x 10 x 10	16 x 14 x 14
10 x 8 x 6	14 x 12 x 8	18 x 14 x 12
10 x 8 x 8	14 x 12 x 10	18 x 14 x 14
10 x 10 x 8	14 x 12 x 12	18 x 16 x 10
12 x 12 x 8	14 x 14 x 12	18 x 16 x 12
12 x 9 x 9	16 x 12 x 12	18 x 16 x 14
12 x 10 x 8	16 x 14 x 8	18 x 16 x 16

- Collars / Dampers installed on T-Wyes upon request.
- Lined T-Wyes available upon request.
- Reverse T-Wyes available upon request.
- Other sizes, gauges & materials available upon request.



Dual T-Wyes & Tees

Available Upon Request		
 DUAL T-WYE	 DUAL TEE	 TRUE TEE
 PANT WYE	 SPLITTER WYE	 AIRFLOW TEE

Tapers & Reducers

Size	
Short	Surefit
5 x 4	10 x 8
6 x 4	12 x 8
6 x 5	12 x 10
7 x 6	14 x 10
8 x 6	14 x 12
8 x 7	16 x 12
9 x 8	16 x 14
10 x 8	18 x 14
10 x 9	18 x 16
12 x 10	20 x 16
14 x 12	20 x 18
16 x 14	22 x 18
18 x 16	24 x 20
20 x 18	-

- Std: Short tapers 6" – 8" high, bare of beaded.
Long tapers available on request.
- Collars / Dampers installed on tapers available upon request.
- Lined Tapers available on request.
- Other sizes, gauges & materials available upon request.



BARE



LINED



BARE

Cookie Cutters

Pancake Reducer

Size			
4 x 3	8 x 6	10 x 9	14 x 12
5 x 3	8 x 7	12 x 10	16 x 14
5 x 4	9 x 8	14 x 10	18 x 16
7 x 6	10 x 8	-	

- Std. Overall Height: 4" nominal.
- Other sizes, gauges & materials available upon request.



Dampers & Sleeves

Jiffy Damper w/ Hardware	Jiffy Damper in Sleeve
Size	Size
5 – 14"	5 – 14"
<ul style="list-style-type: none"> *Includes 1 handle, 1 blade, 2 wing nuts, 2 bearings. Standard: Sleeve w/ Jiffy Damper. Made to SMACNA standards. Other sizes available upon request. 	



JIFFY DAMPER









SLEEVE w/ JIFFY DAMPER

3/8 Dampers w/ Sleeve

<ul style="list-style-type: none"> Std. size 6" - 22". Sleeve length 10" – 14". Crimped one end. All galvanized steel. Made to SMACNA standards. Standard hardware: 3/8 rod, bushings, 1.5" standoff regulator handle. Disks made from 22 Ga. min. Sleeves made to SMACNA standards. Other sizes, gauges, and materials are available upon request.
--



SLEEVE w/ 3/8 ROD & STANDOFF

Damper Hardware											
											
DIAL	SQUARE BEARING	SPRING	WEDGE LOC	ROUND BEARING	QUADRANT	WING NUT	JIFFY HANDLE	WASHER	BEARINGS	BEARINGS	BEARINGS

End Caps

Size
4" – 22"
<ul style="list-style-type: none">• Standard: Oversized collar to fit over pipe.• Undersized End Caps (plugs) are available upon request.• Other sizes, gauges, & materials available upon request.



Start Collars

Size
4" – 26"
<ul style="list-style-type: none">• Standard: 6" high, dove tail, crimped one end.• Available with or without damper.• Other sizes, gauges, & materials available upon request.



Spin-Ins

Size
4" – 18"
<ul style="list-style-type: none">• Standard: 6" high.• Conical Spin-Ins are available upon request.• Other sizes, gauges, & materials available upon request.



STRAIGHT



**SPIN-IN w/
SCOOP & DAMPER**



CONICAL

Round Duct Connectors

Spiral Coupling

- Standard: 4" – 26" Round, 4" L Galvanized Steel.
- Male/Female Slip into pipes with center Bead.
- Other sizes, gauges, & materials available upon request.



Angle Ring

- Standard: 4" – 26" Round, 4" L Galvanized Steel.
- Male/Female Slip into pipes with center Bead.
- Other sizes, gauges, & materials available upon request.



Dura Flange

- Standard: 8" - 72" Round Galvanized Steel.
- Available in other specialty materials.



Round Flex Connector

- Standard: Vinyl and Galvanized Steel.
- Size: 3 x 3 x 3 or 4 x 4 x 4.
- Gauge: 24 Ga.
- Available in other specialty materials.



Connector Accessories



For 1" Strap up
to 18 Ga.



3/8" or 1/2"
x 10'L



For 3/8" Rod
Reduces noise



Bolts & Nuts
3/8" or 1/2"

Saddles

Radius & Flat

Size	
45°	90°
6 – 18"	6 – 14"
<ul style="list-style-type: none">• All branches on saddles are crimped.• Specify size and orientation of saddle (45° or 90°).• Specify pipe size for radius saddles.• Other sizes, gauges & materials available upon request.	

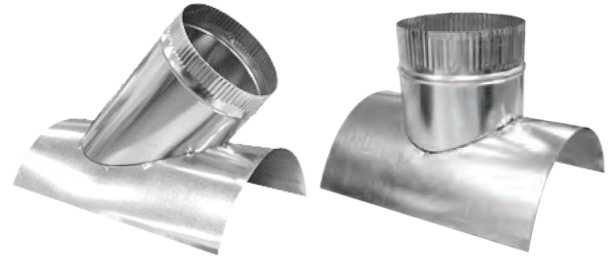

RADIUS

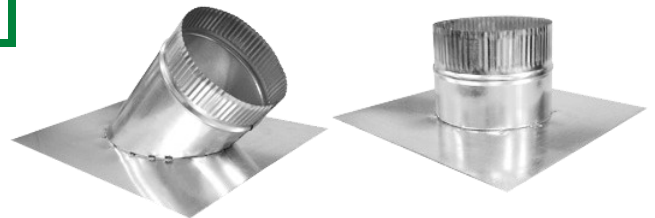

FLAT

Rectangular

- Standard: 1" Flange.
- Specify inside dimension top flange.
- Standard: 4" height.
- Specify pipe size for bottom flange.
- Made to SMACNA standards.
- Sizes, gauges, and materials available upon request.



Boxes

Ceiling

Size
6 – 24"
<ul style="list-style-type: none"> • Standard Collar Height: 2 1/4" with Plaster Ground. • Available in Raw or Flanged upon request. • Side Inlet feed Ceiling Box available upon request. • 6" & 8" High Ceiling box available upon request. • Other sizes, gauges & materials available upon request.



Floor

Size	
8 x 4 x 5	14 x 6 x 7
10 x 4 x 5	14 x 6 x 8
10 x 6 x 6	14 x 8 x 8
12 x 6 x 7	14 x 8 x 9
<ul style="list-style-type: none"> • Standard: 30 Ga. • Available with ears & Damper upon request. • Other sizes, gauges & materials available upon request. 	



Boots

Standard Riser

Size	
8 x 4	12 x 7
8 x 5	14 x 8
10 x 5	14 x 9
10 x 6	-
<ul style="list-style-type: none"> • Standard: 30 Ga., 3-1/4" wide. • Available in Straight, Stackhead or Cone. • Other sizes, gauges & materials available upon request. 	



**STANDARD
 STACKHEAD**



**STANDARD
 STRAIGHT**



**STANDARD
 CONE**

Perimeter

Size	
8 x 4 x 5	12 x 6 x 7
10 x 4 x 5	14 x 6 x 8
10 x 6 x 6	14 x 8 x 9
<ul style="list-style-type: none"> • Available in Straight, Stackhead or Cone. • Other sizes, gauges & materials available upon request. 	



**PERIMETER
 STACKHEAD**



**PERIMETER
 STRAIGHT**



**PERIMETER
 CONE**

China Cap

Size
8 – 14”
<ul style="list-style-type: none">Other sizes, gauges & materials available upon request.



Dryer Vent

Size
3 – 7”
<ul style="list-style-type: none">Other sizes, gauges & materials available upon request.



Eyebrow Vent

Size
4 – 14”
<ul style="list-style-type: none">Available with damper upon request.Other sizes, gauges & materials available upon request.

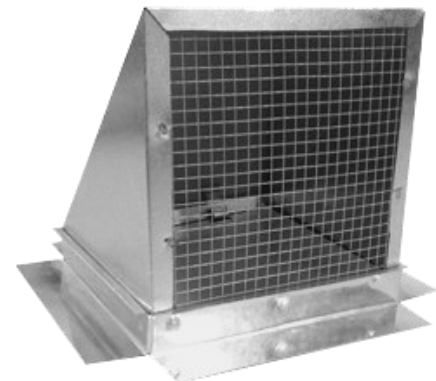

Double Wall B-Vent Pipe & Fittings

Fittings	
Pipe	Reducer
Elbow	Storm Collar
Draft Hood	Tees
Cap	Universal Adapter
Firestop	Wall Thimble
Flex Wall	Wall Support
Increaser	Wye
Adj. Pipe	Collar



Conductor Flashings

Size
1 – 10"
<ul style="list-style-type: none"> Available in Galvanized, Galv. Mesh, Dead Soft Alum., and Shake Base. Other sizes, gauges & materials available upon request.





T-Top Vent

Size
4 – 10"
<ul style="list-style-type: none"> Available in Galvanized, Galv. Mesh, Dead Soft Alum., and Shake Base. Other sizes, gauges & materials available upon request.



RECTANGULAR DUCT

 <p>L-SECTION DUCT</p>	 <p>RECTANGULAR PLENUM W/ CAP</p>	 <p>PLENUM END CAP</p>
 <p>DUCT W/ CONNECTOR</p>	 <p>DUCT 90° ELBOW</p>	 <p>DUCT NON 90° ELBOW</p>
 <p>TRANSITION</p>	 <p>TRANSITIONAL OFFSET</p>	 <p>STRAIGHT OFFSET</p>
 <p>PANT FITTING</p>	 <p>CROSS TEE</p>	 <p>RECTANGULAR TEE</p>
 <p>GOOSE NECK</p>	 <p>PARKER FITTING</p>	 <p>ROOF CURB</p>

Rectangular Duct Connectors

Flange

- Available in 10'L and 20'L Galvanized Steel.
- Recommended for 16 – 26 Ga. Ductwork.
- Tested per SMACNA Class Standards.
- J Flange is 20 Ga. Galvanized Steel.
- Available in specialty metals upon request.



Corners

- Available for J & H.
- Available in standard or universal.
- Available in specialty metals upon request.





Cleats

- Available for J & H.
- Available in standard or universal.
- Available in specialty metals upon request.



Connector Accessories

Gaskets	Bolts & Nuts	Vane / Rail
 <p>Butyl 3/16" x 5/8" OR 5/16" x 3/4" Neoprene</p>	 <p>Bolt: 3/8" x 1-1/4" L Nut: 3/8"</p>	 <p>2" or 4" Vanes or Rails</p>

Return Air Can

Size			
20-1/4" x	12-1/4"	25-1/4" x	12-1/4"
	14-1/4"		14-1/4"
	16-1/4"		16-1/4"
	18-1/4"		18-1/4"
24-1/4" x	12-1/4"	30-1/4" x	12-1/4"
	14-1/4"		14-1/4"
	16-1/4"		16-1/4"
	18-1/4"		18-1/4"

- Specify collar size.
- Other sizes, gauges & materials available upon request.



Drain Pans

Size
<i>Custom Fabrication</i>

- Available with or without drain plug.
- Other sizes, gauges & materials available upon request.



Line Set Cover

Size
<i>Custom Fabrication</i>

- Other sizes, gauges & materials available upon request.



"S" Lock Drives

Size	
1"	26 Ga.
<ul style="list-style-type: none"> Other sizes, gauges & materials available upon request. 	



Standing "S"

Size
10'L
<ul style="list-style-type: none"> Other sizes, gauges & materials available upon request.



Angle

Size
<ul style="list-style-type: none"> 16 Ga. Galvanized Steel - 1 1/2" x 1 1/2". Other sizes, gauges & materials available upon request.

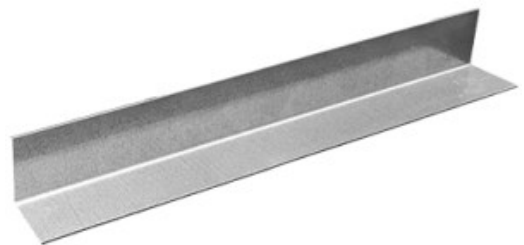

Vanes & Rails

Size
2" & 4" W
<ul style="list-style-type: none"> Single Wall Vanes available upon request. Other sizes, gauges & materials available upon request.



Riser Pipe

Size
8" & 3-1/4" W
10" & 3-1/4" W
12" & 3-1/4" W
14" & 3-1/4" W
<ul style="list-style-type: none">• Available in 3', 7.5' & 10' Lengths.• Available in KD or assembled.• Cap available for all sizes.• Other sizes, gauges & materials available upon request.



Riser Elbows

Size
8" – 14"
<ul style="list-style-type: none">• Standard: 30 gauge, 3-1/4" W.• Available in 90° and 45° Flat or Standard.• Other sizes, gauges & materials available upon request.



Register Boxes

Size
8" – 14"
<ul style="list-style-type: none">• Standard: 30 gauge, 13" H, 3-1/4" W.• Register Boxes with Ears available upon request.• Other sizes, gauges & materials available upon request.



Water Heater Stands

Size
18" L x 18" W x 18" H
20" L x 20" W x 18" H
24" L x 24" W x 18" H
<ul style="list-style-type: none"> Other sizes, gauges & materials available upon request.



Stud Guards

Size		
1-1/2 x	3"	16 ga. 18 ga. 20 ga.
	5"	
	6"	
	9"	
	12"	
	18"	
	24"	
(Wide) 5" x	3"	16 ga.
	3-1/2"	
	5"	
	6"	
	6" (Side Punch)	
	9"	
<ul style="list-style-type: none"> Other sizes, gauges & materials available upon request. 		



Stud Shoes

Size	
Single Stud	18 ga.
Double Stud	
Triple Stud	
<ul style="list-style-type: none"> Other sizes, gauges & materials available upon request. 	



Nail Protection Plates

Size				
1-1/2" x	6"	3" x	6"	16 ga.
	9"		9"	
	12"		12"	
	18"		18"	
	24"		24"	
3-1/2" x	6"	4" x	-	16 ga.
	9"		9"	
	12"		12"	
	18"		18"	
	22"		22"	
	24"		-	
5" x	6"	6" x	6"	16 ga.
	8"		-	
	9"		9"	
	12"		12"	
	18"		18"	
	24"		24"	
8" x	12"	-	-	16 ga.
	18"		-	
	24"		-	

• Other sizes, gauges & materials available upon request.

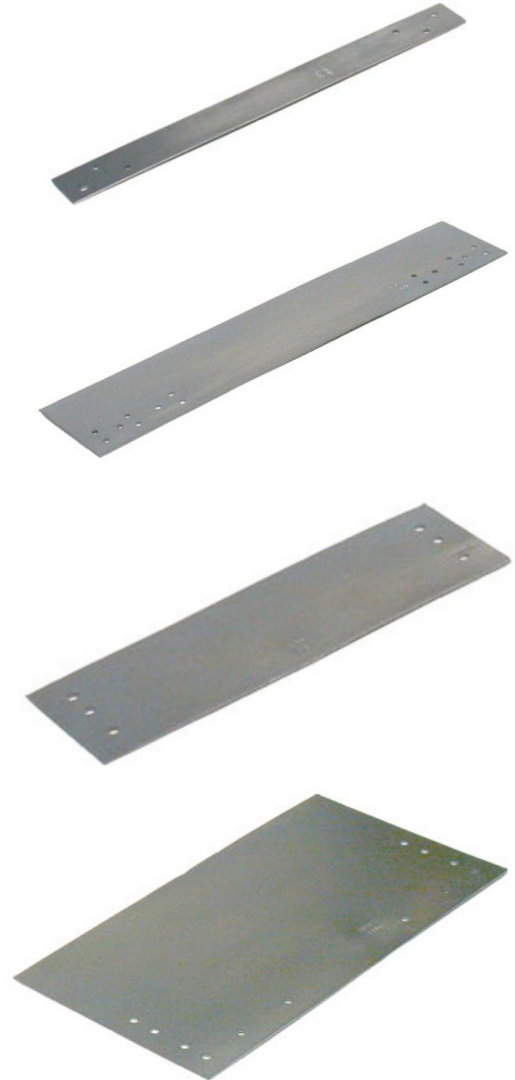

BOCA Plates

Size	
5" x 8"	16 Ga.

• Self-nailing.
 • Other sizes, gauges & materials available upon request.



Pipe Clamps

Size	
1/2"	20 Ga.
3/4"	
1"	
1-1/4"	
1-1/2"	
2"	
2-1/2"	
3"	
3-1/2"	
4"	
5"	
6"	



Tub Hangers

Size	
1-1/2" x 6"	16 Ga.
<ul style="list-style-type: none"> Other sizes, gauges & materials available upon request. 	



Heavy Duty Hinges

Size	
2" x 1-9/16"	7 Ga.
3" x 2"	
<ul style="list-style-type: none"> Butt hinge w/ screw holes. 	

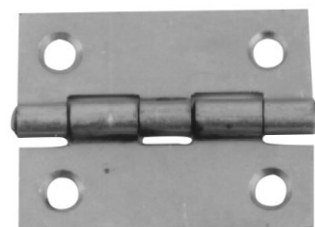

Access Doors

Duct & Drywall

Door Size	
6 x 6	16 x 16
8 x 8	18 x 18
10 x 10	20 x 20
12 x 12	22 x 22
14 x 14	24 x 24

- Duct doors are dovetail, hinged, & cammed.
- Drywall doors are hinged & screw lock.



Round Door



Door Size	Pipe Size
8 x 4	5 – 6"
	7 – 9"
	10"
	12 – 14"
12 x 8	16"
	18"
	20"
	22"

- Other sizes, gauges, & materials available upon request.

High Temp Access Door



Door Size
10 x 6
12 x 8
18 x 14
24 x 18

- Standard: Flat 1000°, 2000° door available upon request.
- Round fire door & other temperature ratings available upon request.
- Other sizes, gauges, & materials available upon request.

Hangers & Supports

Hanger Strap

Size	Ga.
1-1/2" x 10' L	14
1-1/2" x 10' L	16
1" x 10' L	16
1" x 10' L	20
1-1/2" x 10' L	20
1-1/2" x 80' L (No holes)	24
1-1/2" x 80' L (w/ holes)	24
1-1/2" x 80' L (No holes)	26
1-1/2" x 10' L (w/ holes)	26
<ul style="list-style-type: none"> Other sizes, gauges, & materials available upon request. 	



Threaded Rod

Description	Size
Threaded Rod	3/8" x 10' L
	1/2" x 10' L
<ul style="list-style-type: none"> Various other sizes & materials available upon request. 	



Unistrut

Description	Size
Unistrut	1-5/8", 2.5" x 9/16" Slots



Belly Bands

Description	Size
Single Bands	4" – 50"
Double Bands	
<ul style="list-style-type: none"> Other sizes, gauges & materials available upon request. 	



Dura-Blok

Description	Size
Dura-Blok	DB10
	1", 500 lbs.



Iso Spring Hangers

Spring Load	Mount Load
55 lbs.	79 lbs.
79 lbs.	143 lbs.
106 lbs.	-
143 lbs.	-
<ul style="list-style-type: none"> All types of spring isolators & hangers. Most available in stock. 	



Iso Pads

Size
2" x 2" Squares
<ul style="list-style-type: none"> Super duty rubber pads 3/4"



Dampers Hardware & Screws



DIAL



SQUARE BEARING



SPRING LOC



JIFFY DAMPER



WEDGE LOC



ROUND BEARING



QUADRANT

Hardware	
Damper	Spring Loc
Dial	Wedge Loc
Square Bearing	Quadrant
Round Bearing	Handle



OPEN /
CLOSED
BEARING



SPRING
BEARING



STAMPED
BEARING



WINGNUT



JIFFY
HANDLE



WASHER

Screws / Bolts / Nuts & Rivets

- Screws for sheet metal and wood are available in different in sizes.
- Screws are available in Tek or Zip types.
- Bolts, nuts, and washers are also available in assorted sizes.
- Rivets are available in Aluminum & Stainless Steel.
- Sheet Metal tools are in stock.



Duct & Fire Wrap

Product	Size
Duct Liner Insulation	1/2", 1", 1-1/2" & 2" <ul style="list-style-type: none"> • Various sizes available in stock. • Available in different densities. • Available in 50'L & 100'L.
FSK Insulation	1-1/2" & 2" & 3" <ul style="list-style-type: none"> • Specialty wrap available upon request.
Fire Wrap Insulation	1-1/2" <ul style="list-style-type: none"> • Available in 24" & 48" W
Foil Insulation	5/16" 36" W, 50" L R-6 Value



Duct Cover Film

- Standard: 2.5mil, blue.
- Comes in 24" & 36", 200' long.
- Protects and seals duct from contaminants.
- Meets SMACNA Standards.
- UV resistant, tear, & puncture strength.
- High tack and no residue upon removal with anti-bacterial adhesive agents.
- Other sizes available upon request

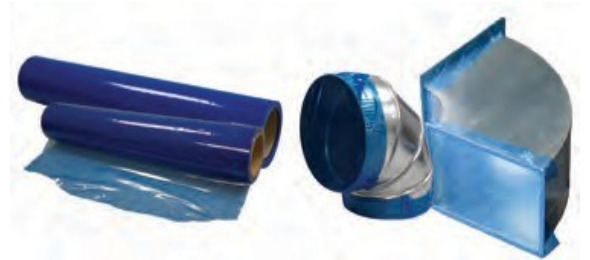

Flex Connector

Size
3 x 3 x 3 (100' roll)
4 x 4 x 4 (100' roll)
<ul style="list-style-type: none"> • Standard: Vinyl. • Neoprene & other materials available upon request.



Rod Anchors

Wood

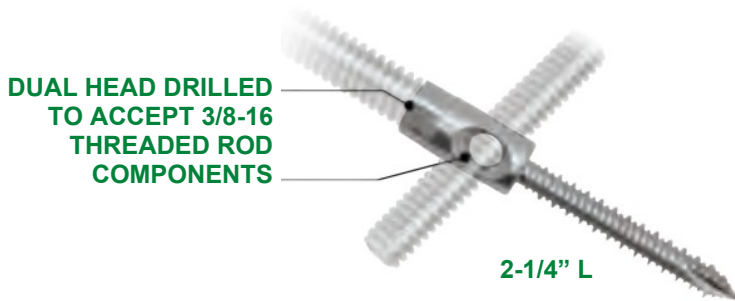

- End-drilled & tapped for attaching 3/8-16 threaded components to wood.
- Solid, one piece cold formed part. Head cannot spin off or unscrew from body.
- Type 17-point cuts threads into wood and wax coating reduces installation torque.

Concrete

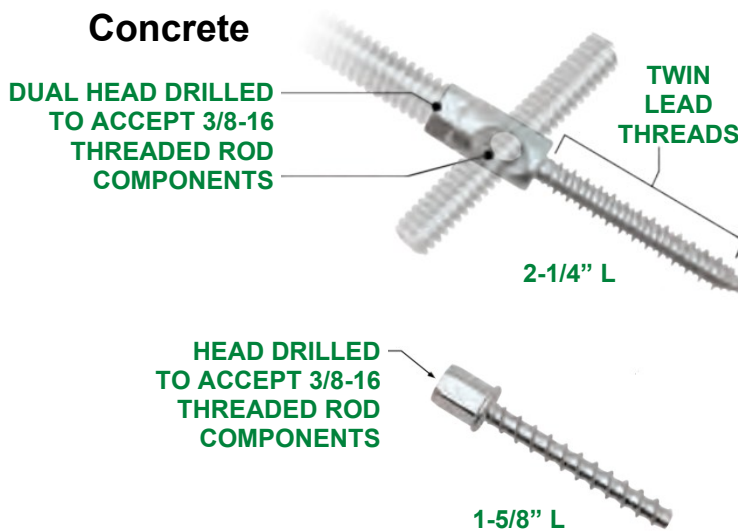

- End-drilled & tapped for attaching 3/8-16 threaded components to concrete.
- Solid, one piece cold formed part. Head cannot spin off or unscrew from body.
- Gimlet (tapered threads) point allows for easy starting in pre-drilled hole.

- Installs w/ standard 1/4" ANSI drill bit.
- Faster installation resulting in labor savings.
- Thread design offers low installation torque.
- Tough threads for tapping high strength concrete.

Steel

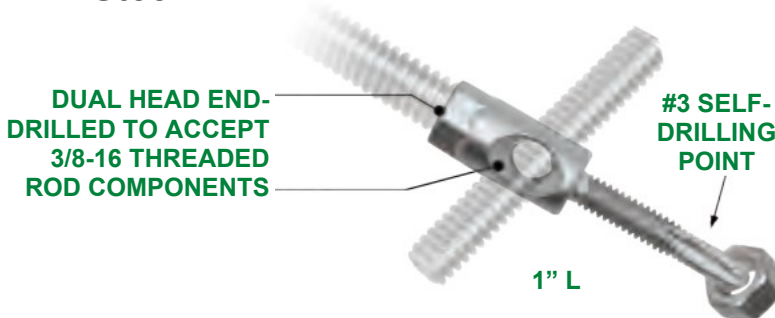

- End-drilled & tapped for attaching 3/8-16 threaded components to steel.
- Solid, one piece cold formed part. Head cannot spin off or unscrew from body.
- #3 self-drilling point for steel thicknesses of .060 - .250".
- Includes backing nuts, which greatly improves pullout values in thin material and meet certain UL/FM requirements.

Adapter



- One-piece anchor threads into installed 3/8-16 HangerMate anchor.
- No special tools required; simply install any 3/8" HangerMate anchor, then thread adapter into it by hand.

Hanger Hardware

Description	Size
Beam Clamp "C" Type w/ Locknut	3/8"
<ul style="list-style-type: none"> Other sizes available upon request. 	



Description	Size
Side Beam Bracket Angle	2" x 2" w/ 3/8" holes
<ul style="list-style-type: none"> Other sizes available upon request. 	



Description	Size
Beam Clamp Strap	3/8" x 12"
Beam Clamp Adj. Strap	3/8" x 12"
<ul style="list-style-type: none"> Other sizes available upon request. 	



Description	Size
Spring Nut	3/8"
	1/2"



Description	Size
T-Bar Wire	8'L, 12 Ga.
	10'L, 12 Ga.
	12'L, 12 Ga.
	14'L, 12 Ga.



Duct & Foil Tape

Type	Size	Specification
Al. Foil	3" x 50 yd.	UL Non-Printed
	2.5" x 60 yd.	UL Printed
Al. Foil Grip	4" x 50 ft.	UL Non-Printed
	3" x 100 ft.	UL Non-Printed
Line Set	2" x 60 yd.	UL Printed
Cloth	2" x 60 yd.	UL Non-Printed
	2" x 60 yd.	UL Printed
Flag	13/16" x 150 ft.	Non-Printed
Flex	2" x 120 yd.	UL Printed
	2" x 120 yd.	UL Printed
FSK	3" x 150 ft.	UL Non-Printed



Duct Sealer, Adhesives & Fire Stop

DP1010/1020/1030
CCWI - 181
Silicone
Fire Stop
Spray Adhesive
2" Chip Brush
Caulking Gun
<ul style="list-style-type: none"> • DP1010 and DP1020 available in Cartridge or Gallon. • Caulking available in clear or white. • Duct liner adhesive available in 5 Gal., 55 Gal. & Spray cans. • Fire Stop 10.5oz. Cartridge.



Copper Fittings

Fittings
Adapters
Bushings
Couplings
Elbows
Street Elbows
<ul style="list-style-type: none"> Various sizes available upon request.



Copper Line Set

Size
1-1/8" x 3/8" x 3/4" ins.
3/4" x 3/8" x 3/4" ins.
7/8" x 3/8" x 3/4" ins.
<ul style="list-style-type: none"> Other sizes, gauges & materials available.



PVC Pipe & Fittings

Fittings	
Pipe	Elbows
Adapters	Traps
Couplings	Tees
Caps	Drain Slip
Bushings	Cement / Primer
<ul style="list-style-type: none"> Various sizes, schedules & materials available. 	

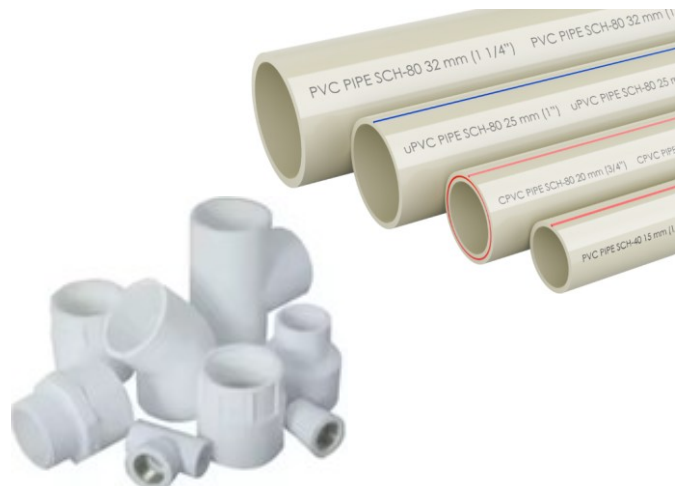

Service Gases

Gases	
Oxygen	
Acetylene	



Brazing Alloy

- Contains 6% silver solder.
- Designed to flow and melt like 15% silver alloy.



Black Iron Pipe & Fittings

Fittings	
Pipe	Elbows
Couplings	Caps
Bushings	Tees
Plugs	Sealant Tape

- Various sizes, schedules & materials available.



Gas Line / Connectors

Size
1/2" MIP x 1/2" FIP Ball
3/8" MIP x 1/2" FIP Ball

- Grommets available upon request.



Thermostat Wire

Ga.	Length
18-5	250'
18-6	250'
18-8	250'
18-10	250'
20-5	250'
20-6	250'
20-8	250'

- Plenum rated wire available upon request.
- Other lengths available upon request.



Whip Kits

Size	Length
1/2"	6'
3/4"	6'

- Whips & fittings sold in bulk orders.



Pigtails / Power Cords

Size
6' L

- Grommets available upon request.



Disconnect & Fuses

Size
30 amp
60 amp



Coil Cleaner

Size
Gallon
Aerosol Can



Freon

R22
R410A



Zip Ties

Size
12", 24", 36" & 48" L
<ul style="list-style-type: none">• Heavy duty, black nylon.• Various size packs available.

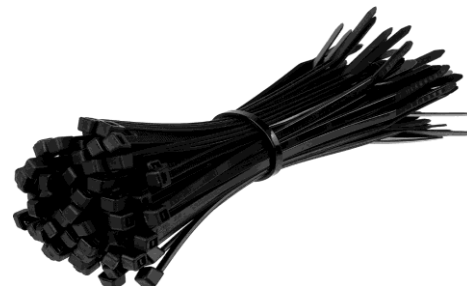

Stamped Grilles & Registers

Size		
2-Way	3-Way	4-Way
8 x 4	8 x 4	8 x 8
10 x 6	10 x 6	10 x 10
12 x 6	12 x 6	12 x 12
12 x 8	12 x 8	14 x 14
14 x 6	14 x 6	-
14 x 8	14 x 8	-
-	14 x 10	-



Stamped Return & Filter Grilles

Size	
Return Grille	Return Filter Grille
10 x 6	24 x 12
10 x 10	24 x 14
14 x 6	24 x 16
14 x 8	24 x 18
14 x 14	24 x 20
20 x 20	30 x 14
24 x 16	30 x 20
-	36 x 20

• Other sizes available upon request.



Bar Type Grilles & Registers

Size	
1-Way	3-Way
8 x 4	10 x 6
10 x 6	10 x 10
10 x 10	12 x 6
12 x 6	12 x 12
12 x 12	14 x 6
14 x 6	14 x 8
14 x 8	14 x 10
14 x 14	-
<ul style="list-style-type: none"> Other sizes available upon request. 	



Bar Type Return & Filter Grilles

Size	
Return Grille	Return Filter Grille
8 x 8	20 x 20
10 x 10	24 x 12
12 x 12	24 x 14
14 x 14	30 x 14
-	30 x 16
-	30 x 20
<ul style="list-style-type: none"> Other sizes available upon request. 	



T-Bar Perforated Supply Diffuser

Size
6"
8"
10"
12"
14"

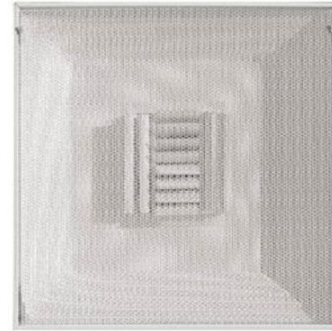

CURVE BLADES

T-Bar Cone Supply Diffuser

Size	
6"	14"
8"	16"
10"	18"
12"	-



T-Bar Perforated Return Air Diffuser

Size	
6"	14"
8"	16"
10"	18"
12"	-

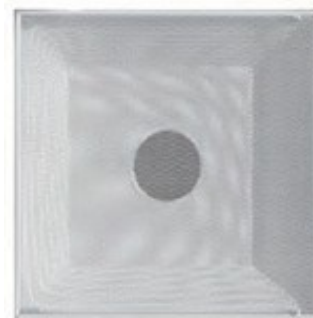

Louvers

Louvers include:

- Extruded Aluminum
 - Formed Steel
 - Stationary
 - Adjustable
 - Combination
 - Operable
 - Acoustical
-
- Various sizes available.



**COMBINATION
LOUVER**



**ADJUSTABLE
LOUVER**

Fire / Smoke Dampers

Fire/Smoke Dampers are used in HVAC systems where both a Fire Damper and Smoke Damper are needed in the same location. The dampers have passed both UL555 and UL555S test requirements for dynamic fire dampers and smoke dampers.

- Class I Ultra-Low Leakage.
- Class II Low Leakage.
- Class III Leakage.
- Fire/Smoke Damper for tunnel & corridor applications.



Backdraft Dampers

From light to heavy duty applications, BGSN Mechanical Construction can provide the perfect backdraft damper for your HVAC needs.

- Light/Medium duty aluminum dampers.
- Counter Balanced Dampers.
- Standard Galvanized Steel Dampers.
- Round Backdraft Dampers also available.



Control Dampers

Commercial control dampers help make buildings more comfortable and energy efficient. They provide high performance and are excellent value.

- Standard steel control damper.
- Low leakage 16ga galvanized blades.
- Mill galvanized (optional stainless steel).
- Accessories/Options: Neoprene blade seals.



Smoke Detectors

- Low-Flow Technology: Both Ionization and Photoelectric models available.
- Interconnect up to 30 units for common functions.
- Flashing LED on detector head indicates normal operation.



Gas Detection System

40 Input Digital Controller

- Supports 40 transmitter/sensors.
- Controls up to 99 relays.
- Digital RS-485 or Analog.
- Relays, LCD display, LED alarm status.



Sensor Digital Controller

- Supports 4 digital transmitter/sensors.
- Controls up to 4 relays.
- RS-485 and Analog outputs.



Gas Detection Sensor

- Electrochemical Toxic sensor.
- Oxygen, Nitrogen Dioxide, Carbon Monoxide, Nitric Oxide, and Ammonia.
- Range fully adjustable.
- 4-20mA or 2-10VDC output fully assignable within the range.
- LCD display.
- Two (2) optional SPDT relays.



SUBMITTAL FORMS

Rectangular Duct & Fittings

- BGSN Mechanical Construction Rectangular Ducts and Fittings are fabricated from galvanized steel per ASTM-ASTM- A-90, A568, A653, A924 and are in accordance with the latest edition of SMACNA Duct construction standards.
- Reference SMACNA tables 1" - 10" W.G. for construction standards and reinforcement schedule.
- Options of stainless steel, aluminum, paint-lock, and other materials are available upon request.
- All ducts are beaded on 12" centers, with first bead 6" from end for extra strength. Cross breaking is available upon request.
- Standard duct lengths are 4', 5', or 6'. Other duct lengths are available in any length requested.
- All slips and drives, nuts, bolts, gaskets, reinforcements, and misc. hardware are included with duct work.
- All ducts and fittings are available bare, lined, or wrapped.
- All rectangular ducts and fittings are shipped assembled, unless otherwise specified.



See next page for rectangular duct submittal forms.

*Submittals and specifications are subject to change without notice.



Round Duct & Fittings

Round Duct Standard Gauge Selection
 Un-Reinforced Positive Pressure
 Galvanized Steel

SMACNA			UMC		
Size (Dia.)	Spiral Seam	Long Seam	Size (Dia.)	Spiral Seam	Long Seam
3 – 8"	28	28	3 – 14"	26	26
9 – 14"	28	28	16 – 22"	24	24
16 – 26"	26	26	24 – 36"	22	22
28 – 36"	24	24	38 – 50"	20	20
38 – 50"	22	22	52 – 60"	18	18
52 – 60"	20	20	62 – 84"	16	16
62 – 84"	18	18	-	-	-



Applies to low pressure systems 2" positive static water.
 Round gauge selection for galvanized Steel as displayed in
 SMACNA & UMC HVAC 'Duct Construction Standard Manual.'

See next page for round duct submittal forms.

*Submittals and specifications are subject to change without notice.



MECHANICAL CONSTRUCTION

716A Mechanical Dr., Slidell, LA 70460
 Ph: (504) 841-9775
 Email: sales@bgsnmechanical.com

CUSTOMER: _____

JOB NAME: _____

JOB ADDRESS: _____

PHONE: _____

DUE DATE: _____

PAGE/BATCH: _____

EMAIL: _____

PICK UP

DELIVERY

ROUND FORM

A END 1 L=10' SPIRAL	B END 1 90°ADJ. ELBOW	C END 2 END 3 END 1 T-WYE	D END 1 START COLLAR	E END 1 END 2 45°SADDLE TAP	F END 1 END 2 90°SADDLE TAP	G END 1 45°FLAT SADDLE TAP	H END 1 90°FLAT SADDLE TAP				
I END 1 L=36' KD PIPE	J END 1 45°ADJ. ELBOW	K END 2 END 3 END 1 TEE	L END 2 END 1 SUREFIT TAPER	M END 1 3/8 DAMPER	N END 1 END CAP	O END 1 L=25' FLEX DUCT	P END 1 L=5' FLEX DUCT W/ COLLARS				
Q END 1 L=6' ALUMINUM FLEX BARE / WARP	R END 5 PLASTER GROUND END 4 CEILING BOX	S END 1 FLEX CONNECTOR	T DEG R END 1 SPOT WELDED 90°ELBOWS	CODE: <input type="checkbox"/> SMACNA <input type="checkbox"/> UMC <input type="checkbox"/> CMC		LEEDS WRAP: Yes <input type="checkbox"/> No <input type="checkbox"/>		EXPOSED: Yes <input type="checkbox"/> No <input type="checkbox"/>		MATERIAL: <input type="checkbox"/> Galvanized <input type="checkbox"/> 304 Stainless Steel #2B <input type="checkbox"/> Paint-Lock <input type="checkbox"/> 304 Stainless Steel #4 <input type="checkbox"/> Aluminum <input type="checkbox"/> Black Iron / CRS	

#	QTY	STYLE	END 1	END 2	END 3	END 4	END 5	R -VALUE			DEG	R	LINER		SPECIAL NOTES	OTHER FITTINGS / ACCESSORIES
1								R4.2	R6	R8			1"	1 1/2"		
2								<input type="checkbox"/>	<input type="checkbox"/>	<input type="checkbox"/>			<input type="checkbox"/>	<input type="checkbox"/>		
3								R4.2	R6	R8			1"	1 1/2"		
4								<input type="checkbox"/>	<input type="checkbox"/>	<input type="checkbox"/>			<input type="checkbox"/>	<input type="checkbox"/>		
5								R4.2	R6	R8			1"	1 1/2"		
6								<input type="checkbox"/>	<input type="checkbox"/>	<input type="checkbox"/>			<input type="checkbox"/>	<input type="checkbox"/>		
7								R4.2	R6	R8			1"	1 1/2"		
8								<input type="checkbox"/>	<input type="checkbox"/>	<input type="checkbox"/>			<input type="checkbox"/>	<input type="checkbox"/>		
9								R4.2	R6	R8			1"	1 1/2"		
10								<input type="checkbox"/>	<input type="checkbox"/>	<input type="checkbox"/>			<input type="checkbox"/>	<input type="checkbox"/>		
11								R4.2	R6	R8			1"	1 1/2"		
12								<input type="checkbox"/>	<input type="checkbox"/>	<input type="checkbox"/>			<input type="checkbox"/>	<input type="checkbox"/>		

#	QTY	STYLE	END 1	END 2	END 3	END 4	END 5	R -VALUE			DEG	R	LINER		SPECIAL NOTES	OTHER FITTINGS / ACCESSORIES
								R4.2	R6	R8			1"	1½"		
13								R4.2 <input type="checkbox"/>	R6 <input type="checkbox"/>	R8 <input type="checkbox"/>			1" <input type="checkbox"/>	1½" <input type="checkbox"/>		
14								R4.2 <input type="checkbox"/>	R6 <input type="checkbox"/>	R8 <input type="checkbox"/>			1" <input type="checkbox"/>	1½" <input type="checkbox"/>		
15								R4.2 <input type="checkbox"/>	R6 <input type="checkbox"/>	R8 <input type="checkbox"/>			1" <input type="checkbox"/>	1½" <input type="checkbox"/>		
16								R4.2 <input type="checkbox"/>	R6 <input type="checkbox"/>	R8 <input type="checkbox"/>			1" <input type="checkbox"/>	1½" <input type="checkbox"/>		
17								R4.2 <input type="checkbox"/>	R6 <input type="checkbox"/>	R8 <input type="checkbox"/>			1" <input type="checkbox"/>	1½" <input type="checkbox"/>		
18								R4.2 <input type="checkbox"/>	R6 <input type="checkbox"/>	R8 <input type="checkbox"/>			1" <input type="checkbox"/>	1½" <input type="checkbox"/>		
19								R4.2 <input type="checkbox"/>	R6 <input type="checkbox"/>	R8 <input type="checkbox"/>			1" <input type="checkbox"/>	1½" <input type="checkbox"/>		
20								R4.2 <input type="checkbox"/>	R6 <input type="checkbox"/>	R8 <input type="checkbox"/>			1" <input type="checkbox"/>	1½" <input type="checkbox"/>		
21								R4.2 <input type="checkbox"/>	R6 <input type="checkbox"/>	R8 <input type="checkbox"/>			1" <input type="checkbox"/>	1½" <input type="checkbox"/>		
22								R4.2 <input type="checkbox"/>	R6 <input type="checkbox"/>	R8 <input type="checkbox"/>			1" <input type="checkbox"/>	1½" <input type="checkbox"/>		
23								R4.2 <input type="checkbox"/>	R6 <input type="checkbox"/>	R8 <input type="checkbox"/>			1" <input type="checkbox"/>	1½" <input type="checkbox"/>		
24								R4.2 <input type="checkbox"/>	R6 <input type="checkbox"/>	R8 <input type="checkbox"/>			1" <input type="checkbox"/>	1½" <input type="checkbox"/>		
25								R4.2 <input type="checkbox"/>	R6 <input type="checkbox"/>	R8 <input type="checkbox"/>			1" <input type="checkbox"/>	1½" <input type="checkbox"/>		
26								R4.2 <input type="checkbox"/>	R6 <input type="checkbox"/>	R8 <input type="checkbox"/>			1" <input type="checkbox"/>	1½" <input type="checkbox"/>		
27								R4.2 <input type="checkbox"/>	R6 <input type="checkbox"/>	R8 <input type="checkbox"/>			1" <input type="checkbox"/>	1½" <input type="checkbox"/>		
28								R4.2 <input type="checkbox"/>	R6 <input type="checkbox"/>	R8 <input type="checkbox"/>			1" <input type="checkbox"/>	1½" <input type="checkbox"/>		
29								R4.2 <input type="checkbox"/>	R6 <input type="checkbox"/>	R8 <input type="checkbox"/>			1" <input type="checkbox"/>	1½" <input type="checkbox"/>		
30								R4.2 <input type="checkbox"/>	R6 <input type="checkbox"/>	R8 <input type="checkbox"/>			1" <input type="checkbox"/>	1½" <input type="checkbox"/>		
31								R4.2 <input type="checkbox"/>	R6 <input type="checkbox"/>	R8 <input type="checkbox"/>			1" <input type="checkbox"/>	1½" <input type="checkbox"/>		
32								R4.2 <input type="checkbox"/>	R6 <input type="checkbox"/>	R8 <input type="checkbox"/>			1" <input type="checkbox"/>	1½" <input type="checkbox"/>		
33								R4.2 <input type="checkbox"/>	R6 <input type="checkbox"/>	R8 <input type="checkbox"/>			1" <input type="checkbox"/>	1½" <input type="checkbox"/>		
34								R4.2 <input type="checkbox"/>	R6 <input type="checkbox"/>	R8 <input type="checkbox"/>			1" <input type="checkbox"/>	1½" <input type="checkbox"/>		
35								R4.2 <input type="checkbox"/>	R6 <input type="checkbox"/>	R8 <input type="checkbox"/>			1" <input type="checkbox"/>	1½" <input type="checkbox"/>		
36								R4.2 <input type="checkbox"/>	R6 <input type="checkbox"/>	R8 <input type="checkbox"/>			1" <input type="checkbox"/>	1½" <input type="checkbox"/>		